

---

Henry Radio  
Linear Amplifiers

---

Operating and Maintenance  
Manual

---

3K Classic Mark II  
3K Classic X Mark II ✓  
5K Classic

---

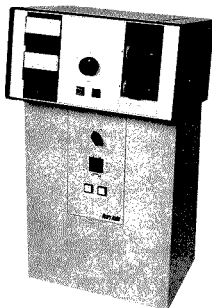

**HENRY RADIO**

SECTION 1. SPECIFICATIONS.

TYPE AND FUNCTION OF EQUIPMENT - All these models are floor console linear amplifiers RF power amplifiers operating in the 3.5-30 MHz frequency range. They can be used for communications, industrial, or scientific applications.

TYPE OF EMISSION - - - - - SSB, AM, CW, FM or RTTY.

OUTPUT POWER - 3K Classic Mark II 1500 Watts PEP, 750 Watts Continuous.  
 3K Classic X Mark II 2500 Watts PEP, 1500 Watts Continuous.  
 5K Classic 3500 Watts PEP, 2000 Watts Continuous.

GAIN - 3K Classic Mark II 13 dB nominal.  
 3K Classic X Mark II 14 dB nominal.  
 5K Classic 14 dB nominal.

TUBE COMPLEMENT - 3K Classic Mark II Eimac 3CX1200A7.  
 3K Classic X Mark II Eimac 3CX1200A7.  
 5K Classic 2 x Eimac 3CX1200A7.

DRIVE POWER - 3K Classic Mark II 60 to 100 watts nominal.  
 3K Classic X Mark II 60 to 120 watts nominal.  
 5K Classic 60 to 200 watts nominal.

DUTY CYCLE - - - - - Continuous duty at rated output.

DIMENSIONS - - - - - 32.75" HIGH x 16.50" DEEP x 15.00" WIDE.

SHIPPING WEIGHT - 3K Classic Mark II 125 pounds (1 box).  
 3K Classic X Mark II 175 pounds (1 box).  
 5K Classic 190 pounds (1 box).

COOLING - - - - - Forced air cooling.

POWER REQUIREMENTS - - - - - 3 wire, single phase, 60 Hz.  
 3K Classic Mark II 230 VAC, 30 amps.  
 3K Classic X Mark II 230 VAC, 30 amps.  
 5K Classic 230 VAC, 40 amps.

NOTE: All amplifiers can be set up for 50 Hz operation, or 200 VAC operation, or 2 wire 220 VAC operation - - But that special requirement must be specified when ordered.

ALC CIRCUIT - All models have an adjustable ALC feedback circuit to prevent overdrive from a high power exciter.

FREQUENCY RANGE - - - - - 3.5 TO 30 MHz nominal.  
 NOTE: Frequency coverage above 25 MHz is available on export models only because of FCC regulations.

OUTPUT IMPEDANCE - - - - - 50 ohms unbalanced with SWR not to exceed 2:1.

INPUT IMPEDANCE - - - Tuned input circuits are used to allow a 50 ohm input impedance across the frequency range.

METERING - Two panel meters monitor plate voltage, plate current and grid current of the amplifier.

HARMONIC AND SPURIOUS RADIATION - Second harmonic better than 50 dB down. Third order distortion better than 35 dB down at full output.

NOISE LEVEL - - 40 dB down or better below one tone carrier at 1000 watts.

CONTROLS/PROTECTION - Band switch, Load control, Tune control, meter switch, standby switch, SSB/CW switch, circuit breaker ON/OFF switch, primary fuses.

REAR PANEL CONNECTORS - RF input (BNC type connector), RF output (UHF type connector-5K Classic N type connector), ALC feedback (RCA type jack), Relay (RCA type jack).

RELAY KEYING - A built-in DC power supply operates at 12 VDC (3K) or 26 VDC (5K) to key the antenna relay when the relay jack is shorted to ground.

PROTECTIVE DEVICES - High voltage shorting switch, air flow switch on the blower, primary AC fuses, primary circuit breaker, cathode fuse.

PLATE VOLTAGE -	3K Classic Mark II	SSB: 3000 - 3200 VDC nominal.
		CW: 2000 - 2200 VDC nominal.
	3K Classic X Mark II	SSB: 3600 - 3800 VDC nominal.
		CW: 2700 - 2900 VDC nominal.
	5K Classic	SSB: 4200 - 4400 VDC nominal.
		CW: 2700 - 2900 VDC nominal.

NOTE: The plate voltages listed above are nominal and vary with the AC line voltage at the operating position.

OTHER FEATURES - Conservative power supply components for superb dynamic regulation in the high voltage supply.

Resonant choke input and oil filled capacitors to improve HV regulation.

Semiconductor diode rectifiers (1.2 amp, 15 KV) for reliable operation.

Standby switch to connect exciter directly to antenna.

Vacuum output relay on 5K Classic.

DC antenna relay system for hum free operation.

Advanced fast-acting relay circuits on 3K models for semi-break-in CW operation.

All aluminum cabinets with double shielding in the RF sections for minimum cabinet radiation.

Pi-L plate circuit with silver plated tank coil to insure the cleanest most efficient output.

Backed by a 25 year history of the finest RF equipment available to the amateur market.

## SECTION 2. INTRODUCTION

The 3K Classic Mark II, 3K Classic X Mark II, and the 5K Classic are a family of high quality, console model, one-stage linear RF amplifiers designed around the rugged and economical Eimac 3CX1200A7 ceramic triode. All three models employ a grounded grid circuit to insure simplicity of design and years of reliable operation. The amplifiers are completely self contained and use only the highest quality RF and DC components available today.

The 3K Classic Mark II uses a single tube offering about 13 dB of gain (the output is about 20 times the drive power) making it drive easily with lower power solid-state exciters. This model uses a moderate duty power supply for operation in the United States. FCC regulations require that units supplied in the United States can not operate on the 28 MHz band.

The 3K Classic X Mark II is an export, military, or industrial version of the 3K Classic Mark II. This model mates a heavy duty power supply with the 3K Classic RF deck to offer a high gain amplifier with the reliability of an industrial type power supply.

The 5K Classic uses two 3CX1200A7 in conjunction with a special high voltage, heavy duty power supply for a minimum of 3500 watts PEP output in military or commercial applications. This amplifier is available for sale only to military, export, or industrial users.

These are a family of amplifiers because they are all designed around the same basic RF deck design which employs a unique rotary tank inductor not found in any other line of production amplifiers. All the models can be used for SSB, CW, RTTY, or AM operation on any frequency between 3.5 and 30 MHz (subject to United States restrictions on 28 MHz).

Please read the instruction manual carefully before operating the new equipment. Power amplifiers can be damaged by operation out of resonance. The amplifiers are shipped with the tubes installed, so no assembly is required before you can operate the equipment.

**CAUTION:** There are dangerously high voltages present inside the amplifier when the power switch is turned ON. Never remove any covers when the amplifier is plugged in or turned on! Always exercise extreme caution when servicing any amplifier. THE VOLTAGES FROM THE HIGH VOLTAGE POWER SUPPLY CAN BE LETHAL!

## SECTION 3. INSTALLATION

### SECTION 3.1 UNPACKING

When you first receive the amplifier you must carefully inspect first the box and then the amplifier for any sign of damage during shipment. If you see any shipping damage, save the box and packing material and notify the transportation company immediately. It is a good idea to save the box and packing material in any case because they are expensive to replace and are useful in protecting the amplifier should you ever decide to ship it or move it to another location.

Remove the amplifier from its shipping carton and packing material. Your unit is packed into a single carton and is ready to operate with the exception of a power plug. A power plug that mates with the power socket at the operating location must be properly installed as described in section 3.3 before the unit can be operated.

The following accessories should be included with the amplifier.

1	Instruction Manual	1	Warranty Card
1	PL259 Coax Connector (3K)	1	Drive Cable (RG58)
1	N type Coax Connector (5K)	1	Set Fuses
2	Shielded Control Cables		

### SECTION 3.2 OPERATING LOCATION

The amplifier may be located wherever desired provided there is adequate air flow from the bottom of the unit up through the top of the amplifier. Do not restrict the airflow of the amplifier, and never place it too close to a wall that might restrict the airflow into the back of the unit.

You will require a location that has an appropriate 220 VAC power source. A location which avoids environmental extremes of heat, humidity, and dust will keep the amplifier new looking and assure years of reliable operation.

### SECTION 3.3 CABLING

All of the following cables must be connected before operation of the amplifier.

**POWER CABLE** - The amplifier is equipped with a 3-wire AC power cable that is normally wired to accept 220 VAC, 3 wire, 60 Hz, single phase power unless special instructions were given at the time of the order. A factory modification is required for 50 Hz operation, or 200 VAC operation, or for 2-wire european operation.

The three wires in the power cable are black, white, and green. The green wire is chassis ground and the neutral on the 220 VAC plug. The black and white wires connect the "hot" 220 VAC circuits. A power plug is not supplied because there are many different types of 220 VAC outlets. We suggest that you consult with a local electrician about the proper connection

of your plug type.

**CAUTION:** The amplifier will be damaged if the green wire is connected to the 220 VAC terminal. Make sure that the green is connected to the neutral terminal.

**ANTENNA COAX** - Use only RG-8/U coax (or better) to connect the amplifier to the antenna or dummy load. A PL-259 (UHF type) coax connector is included in the accessory kit. Prepare the cable and connector as described in Figure 1 below. The PL-259 mates with the coax jack marked OUTPUT on the rear panel of the amplifier. The 5K Classic uses an N type connector which is supplied in the accessory kit.

**CAUTION:** Never operate the amplifier unless it connected to an antenna or a dummy load capable of handling the output of the unit. You will damage the equipment if you operate it without a load or into a load with an SWR greater than 2:1 (a reflected power more than 10% of the forward power). Measure the antenna's SWR with an SWR meter, using only the exciter output, before operating the amplifier. With the amplifier in the off position, the exciter output will pass through the amplifier directly to the antenna.

**DRIVE CABLE** - The RG-58/U drive cable supplied in the accessory kit connects to the INPUT connector on the rear panel of the amplifier. This connector is a BNC type coax connector. The UHF connector on the other end of the cable must be connected to the RF output connector of the exciter. An adapter may be required if the exciter does not have a matching connector.

**ALC (Automatic Level Control) CABLE** - Plug the gray ALC cable into the ALC OUT phono socket on the rear panel of the amplifier and into the ALC feedback connection on the exciter. If the exciter does not have provision for feedback of ALC voltage from the amplifier, no connection is necessary.

**RELAY CABLE** - The gray relay control cable must be plugged into the phono plug marked RELAY on the back panel of the amplifier. This cable conducts the keying signal from the exciter to switch the amplifier to the transmit condition and must be connected to the socket or connector marked antenna relay (or its equivalent) on the exciter. The exciter needs to supply only a shorting relay contact (closed to ground during transmit) to key the amp.

**CAUTION:** Never apply any voltage to the relay jack of the amplifier! Your amplifier has a built-in power supply which provides the necessary voltage.

Most modern transmitters or transceivers make easy provision for a relay control connection. If the connection is not obvious to you, examine the operating manual of the exciter to find an available unused relay contact that is normally closed during transmit.

Some modern transceivers use diode switching rather than relay switching. Henry amplifiers use 12 VDC (or 26 VDC) relay control voltage, any resistance across the relay control line may keep the amplifier from keying. If your exciter will not key the amplifier, you should check the resistance

FIGURE 1. ASSEMBLING YOUR COAX CONNECTOR.

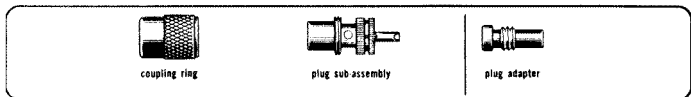

coupling ring



plug sub-assembly



plug adapter

plugs 83-15P, 83-822

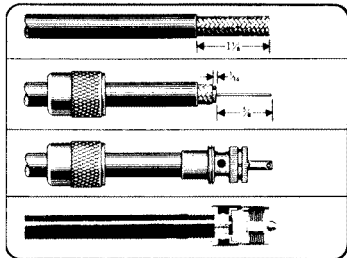

Cut end of cable even. Remove vinyl jacket 1 1/4", except 83-15P plug remove vinyl jacket 1 1/4".

Bare 3/4" of center conductor. Trim braided shield. Slide coupling ring on cable. Tin exposed center conductor and braid.

Screw the plug sub-assembly on cable. Solder assembly to braid through solder holes, making a good bond between braid and shell. Solder conductor to contact. Do not use excessive heat.

For final assembly, screw coupling ring on plug sub-assembly.

across the contact you are using. If there is too much resistance, contact the exciter's manufacturer about possible solutions to the problem.

#### SECTION 3.4 TRANSFORMER TAPS

The amplifier is normally factory wired for 220-230 VAC, 3 wire, 60 Hz operation unless specially ordered otherwise. If the AC mains are different then you will probably have to make a modification in the power supply.

50 HZ OPERATION - Unlike most other amplifiers on the market, most Henry amplifiers use a resonant filter choke. The choke is factory resonated at 60 Hz unless otherwise specified. For 50 Hz operation a third resonating capacitor must be added. This will be done at the factory if specified at the time of order.

FILAMENT TRANSFORMER - The filament transformer is marked ECA 1226 (3K Classic) or ECA 1194 (5K Classic). They are factory tapped for 230 VAC operation. If the AC line voltage is significantly different, you must rewire the taps on the transformer (located in the power supply section).

ECA (1226) 1216 A	ECA 1194
Tap 1 - Common-----	Tap 1 - Common-----
Tap 2 - 200 VAC----	Tap 2 - 200 VAC----
Tap 3 - 210 VAC----	Tap 3 - 210 VAC----
Tap 4 - 220 VAC----	Tap 4 - 220 VAC----
Tap 5 - 230 VAC----	Tap 5 - 230 VAC----
TAP 6 - 240 VAC	Tap 6 - 240 VAC----

NOTE: The nominal filament voltage at the tube is 7.5 VAC. The amplifier does not meter filament voltage, so you must use an external AC voltmeter to measure the filament voltage at pin jacks on the back panel of the RF chassis. The 3K Classic should measure close to 7.8 VAC at the pin jacks. The 5K Classic filaments are in series and the voltage should read about 15.6 VAC. becaif the voltage varies more than 5% from these figures, the taps on the filament transformer should be changed.

HIGH VOLTAGE TRANSFORMER - The 3K Classic Mark II domestic amplifier is supplied with the ECA 1120A. The primary tap connections are listed below:

ECA 1120A	
230 VAC-----	Tap 1
	-----Tap 3
	-----Tap 5
230 VAC-----	Tap 7

The 3K Classic X and 5K Classic are supplied with one of the following high voltage transformers:



(ECA 1171) or ECA 1214A

Common-----Tap 1  
200-210 VAC-----Tap 2  
210-230 VAC-----Tap 3  
230-240 VAC-----Tap 4  
240-250 VAC-----TAP 5

The high voltage transformers are located on the bottom plate of the power supply section.

## SECTION 4. OPERATING CONTROLS

### SECTION 4.1 FRONT PANEL CONTROLS

**OFF/ON POWER SWITCH** - This switch is used to turn the AC power to the amplifier on and off. When the amplifier is turned off, or when the amplifier is in the standby mode, the output of the exciter passes directly to the antenna.

**MULTIMETER AND RELAY CONTROL SWITCHES** - These push-button switches are located below the multimeter. There are two interlocked pairs. The two on the left select the function of the multimeter. The switches select either a plate voltage reading (0 to 10,000 VDC) or a grid current reading (0 to 100 ma) on the multimeter.

The pair of switches to the right enables or disables the keying control circuit of the amplifier. The STANDBY position makes it possible to operate the exciter only without turning off the amplifier.

**SSB/CW SWITCH** - This two position rotary switch selects between two plate transformer taps to assure the correct operating parameters for each type of emission. The amplifier must be retuned when the switch is changed.

**PLATE CURRENT METER** - This meter monitors the plate current of the tube or tubes in your amplifier. The meter scale reads 0 to 1 amp DC.

**PILOT LIGHTS** - The dial lights come on to indicate when the amplifier is turned on.

**FUSES** - The two 3 AG, 8 amp fuses on the front of the amplifier protect all the AC circuits other than the high voltage supply - blower, relay supply, pilot lights, etc.

**LOAD CONTROL** - This control matches the amplifier's output network to the antenna or load. Refer to the calibration chart at the back of the manual for appropriate initial settings for the frequency of operation. A load setting of zero corresponds to minimum loading and a load setting of 100 corresponds to maximum load capacitor mesh.

**TUNE CONTROL** - The TUNE control is a 20 turn vernier dial connected to the variable inductor tank coil. Refer to the calibration chart at the back of the manual for appropriate initial settings for the frequency of operation.

FIGURE 2. OPERATING CONTROLS.

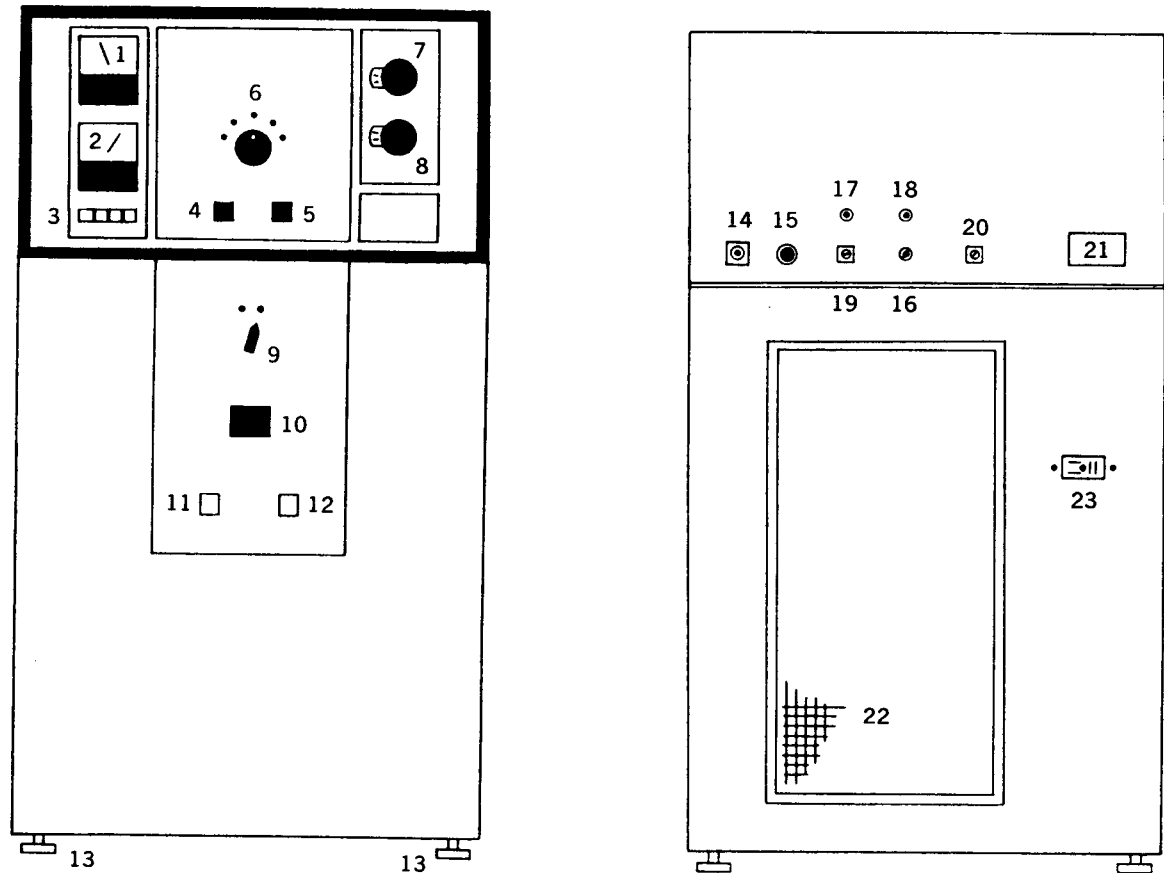

OPERATING CONTROLS - 3K CLASSIC X Mark II and 5K CLASSIC

- |   |                               |
|---|-------------------------------|
| 1. Plate Current Meter.                   | 13. Adjustable Feet.          |
| 2. Multimeter.                            | 14. RF Output Connector.      |
| 3. Multimeter and Relay Control Switches. | 15. Cathode Fuse.             |
| 4. STANDBY Light.                         | 16. RF Input Connector.       |
| 5. POWER Light.                           | 17. ALC Connector.            |
| 6. BAND Switch.                           | 18. RELAY Connector.          |
| 7. TUNE Control.                          | 19. ALC Adjust Potentiometer. |
| 8. LOAD Control.                          | 20. Ground Stud.              |
| 9. SSB/CW Switch.                         | 21. Serial Number Tag.        |
| 10. OFF/ON Power Switch-Circuit Breaker.  | 22. Air Flow Filter.          |
| 11. AC Fuse.                              | 23. AC Power Connector.       |
| 12. AC Fuse.                              |                               |

**BAND SWITCH** - The BAND switch selects the correct tuned input circuit and the appropriate capacitance on the output circuit for the frequency of operation. Listed below are guidelines for the band position relative to operating frequency. NEVER move the BAND switch when the amplifier is keyed.

BAND		OPERATING FREQUENCY
80	.....	3.5 TO 5 MHZ
40	.....	5 TO 10 MHZ
20	.....	10 TO 17 MHZ
15	.....	17 TO 24 MHZ
10	.....	24 TO 30 MHZ

(Approximate)

#### SECTION 4.2 REAR PANEL CONTROLS AND CONNECTIONS

**ALC JACK** - This socket accepts an RCA phono plug (an ALC cable is provided in the accessory kit) to connect a feedback voltage from the amplifier to the exciter. No connection is necessary if the exciter does not have provisions for ALC feedback.

**ALC ADJUSTMENT POTENTIOMETER** - This potentiometer controls the sensitivity of the amplifier's ALC feedback circuit. See the operating section for instructions on how to adjust the ALC circuit.

**RELAY CONTROL JACK** - The RCA jack marked RELAY CONTROL connects the amplifier to the exciter to key the amplifier when the exciter is transmitting. A interconnection cable is supplied in the accessory kit. When the socket is shorted to ground, the amplifier's antenna relay closes. If the amplifier is turned off, or in the STANDBY mode, the relay can not be keyed. Never apply any voltage to this socket.

**RF INPUT CONNECTOR** - This BNC coax connector accepts the drive line from the exciter. The input impedance of the amplifier is nominally 50 ohms.

**RF OUTPUT CONNECTOR** - The nominal output of the amplifier is 50 ohms. Do not operate the amplifier unless an antenna or other 50 ohm load with an SWR better than 2:1 is attached to this connector. An SWR of 2:1 is indicated when the reflected power equals 10% of the forward power. Use only 50 ohm coax, with a power handling capacity equal to the amplifier's rated output, to connect to the load.

**GROUND LUG** - This lug is provided to ground the amplifier's chassis. If you connect the amplifier to a standard 3 pin AC outlet, it should be properly grounded. If such a system is not used, it is a wise idea to connect the ground lug to a good earth ground. A properly grounded chassis reduces the risk of electrical shock and minimizes cabinet radiation.

**CATHODE FUSE** - This 8 AG 1.5 amp fuse protects the cathode circuit from a short circuit. Never exceed the specified current rating when you replace the fuse.

**POWER CORD** - The power cord must be connected to an AC power source capable of supplying the necessary current required by the amplifier. No power AC plug is supplied. Be certain that the power transformer taps are correct for the line voltage at the operating position.

## SECTION 5. OPERATION

### SECTION 5.1 PRELIMINARY SETTINGS

Before you turn on the amplifier, push the STANDBY button on the function switch. Turn on the amplifier with the circuit breaker on the front of the cabinet. The dial lights, blower and STANDBY light should come on when you turn on the power. The 3CX1200A7 requires no significant warmup period so you may use the amplifier within a few seconds of turning it on.

Push the operate button on the function switch and check that the POWER light comes on. Key the exciter to switch the amplifier into the transmit mode, BUT DO NOT APPLY POWER YET. Check that the operating parameters are approximately as follows:

With the SSB/CW switch in the SSB position:

Model	Grid Current	Plate Current	High Voltage
3K Classic Mk II	0 ma	140 ma	3200 VDC
3K Classic X Mk II	0 ma	90-100 ma	3900 VDC
5K Classic	0 ma	200 ma	4500 VDC

With the SSB/CW switch in the CW position:

3K Classic Mk II	0 ma	70 ma	2200 VDC
3K Classic X Mk II	0 ma	70 ma	2900 VDC
5K Classic	0 ma	100 ma	3500 VDC

The high voltage and resting current are very dependent on the AC line voltage at the operating position.

If the tube parameters are significantly different than the above reading, there may be a problem with the amplifier, or the high voltage taps on the power transformer may need to be changed.

### SECTION 5.2 SSB OPERATION

Set the SSB/CW switch to SSB and make sure that the output of the exciter is turned to zero. Set the BAND switch to the appropriate position for the operating frequency. If you have an RF wattmeter, connect it in the output line of the amplifier. The wattmeter must be capable of reading at least 2500 watts. Switch the exciter to the CW mode.

Step 1. Preset the TUNE and LOAD controls of the amplifier using the calibration readings from the TUNE and LOAD settings table in the back of the manual.

Step 2. Gradually increase the power from the exciter to drive the amplifier to about 400 ma of plate current. If you have used the calibration settings provided by the factory, you should see some output power. Adjust the TUNE and LOAD controls alternately for maximum RF power, or maximum plate current if you do not have a wattmeter.

Step 3. Push the grid current button on the function switch so that the multimeter is reading grid current. Increase the drive from the exciter until the grid current is about:

3K Classic Mark II.....	200 ma
3K Classic X Mark II.....	250 ma
5K Classic.....	400 ma

Step 4. If plate current is now less than 600 ma -- increase the LOAD control slightly. If plate current is now more than 600 ma -- decrease the LOAD control slightly.

Step 5. Adjust the TUNE control to dip the plate current (minimum plate current reading).

Step 6. Increase the drive from the exciter until the grid current returns to the level specified above.

Repeat steps 4, 5, and 6 until the following correct operating parameters are reached:

	Grid Current	Plate Current
3K Classic Mark II.....	200 ma.....	600 ma.....
3K Classic X Mark II.....	250 ma.....	600 ma.....
5K Classic.....	400 ma.....	800 ma.....

CAUTION: Do not drive the amplifier for more than 10 seconds when it is not tuned to resonance. Ten seconds tune and 10 seconds off is a good operating habit when tuning up.

Step 7. When the amplifier has been tuned to resonance, note the dial calibration readings so that you can return to that frequency again without retuning. As long as the tube is in good condition and your load stays constant, the dial readings should stay constant for a specific frequency.

Step 8. Switch the exciter to SSB operation and speak into the microphone to drive the amplifier. The meter readings for voice peaks will be approximately 1/2 of the meter readings during tuneup. Output readings will not follow the speech pattern.

### SECTION 5.3 CW OPERATION

Follow the tuning procedures above for SSB with the SSB/CW switch in the CW position. The meter readings will be about 60% of the values of the SSB readings.

### SECTION 5.4 ALC ADJUSTMENT

The amplifier is shipped with the ALC ADJUST control on the pack panel fully counterclockwise (off). If the ALC feedback circuit is used, the adjustment must be made only once, unless a new exciter is used. After the ALC adjustment is made, use the locknut on the potentiometer shaft to lock the control into place.

With the ALC ADJUST control fully counterclockwise, tune the amplifier for SSB operation. Drive the amplifier to about 800 ma of plate current and then rotate the ALC ADJUST control clockwise until the grid current just begins to decrease. If the exciter can not drive the amplifier to 800 ma of plate current, there is no need to adjust the ALC control.

The ALC circuit is designed to prevent overdrive (and therefore distortion) from a high powered exciter. If the exciter does not put out more than 120 watts, the ALC connection is probably not necessary.

#### SECTION 5.5 ALTERNATE TUNING METHOD

When you have verified the TUNE and LOAD dial settings for each band and are more comfortable with your amplifier, the entire tuning procedure can be completed in a few seconds.

This alternate tuning method (tuning for maximum output) requires a good RF power meter capable of measuring at least 2500 watts at the output of the amplifier. Set the TUNE and LOAD controls at the predetermined settings for the frequency desired. Apply drive from your exciter to the amplifier and bring the RF output reading to about 600 or 700 watts. Adjust the TUNE and LOAD controls alternately to carefully peak the amplifier's output as shown on the RF wattmeter. The amplifier will now be tuned to resonance.

#### SECTION 5.6 OPERATING PRECAUTIONS

Please keep the following precautions in mind to insure safe and reliable operation of the amplifier for many years.

Voltages inside the amplifier can be lethal. Never try to disable the protection circuits designed into the amplifier. Never operate the amplifier with any of the panels removed.

Always tune the amplifier for resonance at the operating frequency before transmitting.

Never switch the BAND switch while the amplifier is keyed. You will likely have a very expensive repair bill to replace the BAND switch if make this mistake.

Never operate the amplifier into a load with an SWR greater than 2:1.

The components in the amplifier are specifically designed for operating parameters in line with the rated output listed in the specifications. Excessive drive causing output in excess of that specification will shorten tube life and endanger the reliability of other components.

## SECTION 6. MAINTENANCE PROCEDURES

Any time you have a problem with the amplifier be certain to check the fuses before continuing troubleshooting. Never use a higher value fuse than the one specified on the amplifier. You can cause damage to the unit.

### SECTION 6.1 INPUT MISMATCH

All Henry amplifiers have a tuned input coil for each band so that there is a relatively good match between the amplifier and exciter. If for some reason you find high reflected power between the exciter and amplifier in the transmit mode for one band only, you will have to retune the input coil of the band where the problem exists. The RF chassis of the amplifier must be removed from the wraparound to retune these circuits. Refer to Section 7 for a description of the disassembly procedure. The input coils are adjusted through holes on the left side of the RF chassis. The coils are labeled as to which band they tune.

To tune the input, you must insert an SWR meter in the drive cable. Key the exciter at the desired operating frequency, tune the amplifier to that frequency, then adjust the input coil for minimum reflected power in the drive cable.

If the high SWR problem appears on every band, you must assume that the input antenna relay is out of its socket, either totally or partially. Also a short in the coax between the input connector and the RF chassis can cause the same problem.

### SECTION 6.2 REDUCED RECEIVER SENSITIVITY

If you see reduced receiver sensitivity in your exciter when the amplifier is being used, or when the amplifier is in standby, you should check the input antenna relay and then output antenna relay to see if they have vibrated out of their socket, or if they have a bad contact. The output relay on the 5K Classic is a vacuum relay. After you have ruled out one of those problems you must check the input and output coax for a short or intermittent contact.

### SECTION 6.3 TUBE PROBLEMS

**EXCESSIVE PLATE CURRENT** - This problem often indicates a bad tube, and the only cure is to replace the tube. The problem can be partial, showing high resting current, or full short causing the circuit breaker to blow. The 5K Classic can not be operated with just one tube because the filaments are in series. Note that a plate current short will probably blow the cathode fuse.

Excessive resting plate current can often be caused by a failure of the bias circuit around D1. Replace the defective diode or resistor to solve the problem.

GRID/FILAMENT SHORT - A failure of this nature can cause the amplifier to show plate current even when it is not keyed. Another indication of this problem is negative grid current on the grid meter. The tube must be replaced to solve the problem.

PLATE SHORT - A failure of this nature will cause the circuit breaker to blow. Other high voltage shorts can cause the same symptom so you must isolate the cause. If the shorted condition causes excessive plate current, the cathode fuse will blow.

LOW OUTPUT - A 3CX1200A7 can offer many years of reliable service, but if you operate the amplifier out of resonance the tubes will eventually go soft making it impossible to drive the amplifier to full output.

#### SECTION 6.4 RELAY CIRCUIT PROBLEMS

RESTING CURRENT WHEN AMPLIFIER IS NOT EXTERNALLY KEYED - If the relay is keyed you will see normal tube resting current, therefore you must suspect that the relay cable, exciter's relay, or one of the relays is malfunctioning. Isolate the problem by disconnecting the relay cable. If the problem persists, the cause is in the amplifier. If the problem disappears the cause is in the exciter or cable. A problem in the amplifier would normally be caused by a short in the 12 VDC (26 VDC for 5K Classic) circuit or a defective relay.

THE AMPLIFIER WILL NOT KEY - Suspect first the relay cable, then check the exciter's relay circuit. Henry amplifiers key with 12 VDC (24 VDC for 5K) and some modern exciters use diode switching. This combination sometimes causes a voltage drop in the relay line so that the relays will not key. Measure the resistance across the exciter's relay contact. Any resistance can cause a voltage drop. If this is the case, a more sensitive external relay may be required or a modification might be required to the exciter. Another cause could be that the relay power supply in the amplifier has failed not providing the necessary voltage. Check the voltage at the center pin of the relay jack. It should be between 12 and 20 VDC (20-30 VDC for 5K Classic). If there is no voltage check first the 3 AG fuses, then the components in the relay power supply. A last possible cause is a defective relay.

#### 6.5 HIGH VOLTAGE CIRCUIT PROBLEMS

The high voltage in the amplifier can be lethal! Always disconnect the amplifier from its AC power source and turn off the power switch before you work on the equipment.

NO PLATE CURRENT WITH EXCESSIVE GRID CURRENT - This is a sure indication of a break in the high voltage line between the power supply and the tube. You MUST unplug the amplifier from the AC line and trace the circuit with an ohmmeter to find the break.

HIGH VOLTAGE SHORT - A high voltage short will usually result in the circuit breaker turning the amplifier off. Also there will often be an arc indicating the source of the short. Isolate the short by disconnecting the



high voltage lead between the RF section and the power supply. If the short disappears the problem is in the RF chassis or B- return. If the problem persists, the problem is in the power supply. If the short is in the RF chassis or in the B- line, remove the top cover and search for any visible sign of a short. Then use an ohmmeter to trace the circuit from the high voltage connector to the blocking capacitors, including the tube(s). If the problem is in the power supply you will again have to check for visible signs of a short, or use an ohmmeter to locate the short. Often however a high voltage short will only show when the high voltage is applied. To locate such a short it may be necessary to unsolder leads to remove components from the circuit until the short disappears. Start with the filter capacitor, move back to the filter choke, and then the rectifiers. Finally remove the power transformer from the circuit. Keep in mind that a high voltage short may blow the cathode fuse in the RF chassis.

**LOW PLATE VOLTAGE** - This problem is usually an indication of low AC line voltage. It can only be solved by retapping the power transformer as described in Section 3.4.

**HIGH PLATE VOLTAGE** - This problem can be caused by high AC line voltage and should be brought into specification by retapping the power transformer as described in Section 3.4.

The problem can also be caused when the filter choke is out of resonance. A resonated filter choke is used in the design because of its superb linearity and voltage regulation. However, the choke must be resonated to a specific AC frequency (50 Hz or 60 Hz) using capacitors. If the capacitor fails, or if the amplifier was set up at the factory for a different AC frequency, the voltage regulation becomes poor. The result will be excessive high voltage when the amplifier is not transmitting and excessive voltage drop during transmit. Three .01 mf capacitors are used to resonate the filter choke for 50 Hz and two are used for 60 Hz.

**NO HIGH VOLTAGE METER READING** - The most likely cause is a blown cathode fuse in the RF chassis. After that, other likely causes are a failure or value change of the high voltage multiplier resistor in the power supply, or a failure in the meter circuit.

## SECTION 6.6 BLOWER PROBLEMS

These amplifiers have an airflow switch in the blower which turns the amplifier off to protect the tube in case of blower failure. So if you find that the amplifier is intermittently turning off or if the pilot lights will not come on be sure to check the airflow switch on the blower.

The blower is one of the most susceptible parts to transportation damage. Henry amplifiers use squirrel cage blowers because of their exceptional air blowing capability in a small size. But the blower assembly can be easily damaged if the amplifier is dropped during shipment. When the amplifier is installed make certain that a strong flow of air is coming out the top of the amplifier when it is turned on. Other indications of blower damage can be a resonance in the amplifier cabinet caused by an unbalanced fan, an unequal flow of air between the two tubes in the 5K Classic, or mechanical noise from the blower.

If the blower is not operating, check the 3 AG fuses on the front of the amplifier. If the fuses are blown, the pilot lights will not come on.

#### SECTION 6.7 OUTPUT PROBLEMS

The first thing to check if there is low output from the amplifier is to make sure you are getting sufficient drive from the exciter. When the amplifier is working properly you will get 20 to 25 times amplification (13 to 15 dB gain). Some modern exciters have power drop off on some bands so therefore the amplifier will put out correspondingly less power. Since the amplifier is superbly linear, its output varies directly with its input.

The next thing to check is the input and output cabling. An intermittent or shorted drive cable can cause low or no input to the amplifier. This will usually show up by operating the exciter through the amplifier (in STANDBY) and measuring the input and output power. Low drive can also be seen as low grid current during transmit. Also check the output cables. Shorted coax is not uncommon and a poor job of installing coax connectors can cause severe output problems.

Other problems that can reduce output are low plate voltage, insufficient filament voltage, low AC line voltage, or a bad tube(s).

#### SECTION 6.8 AC LINE VOLTAGE PROBLEMS

The amplifier is normally factory wired for 220-230 VAC, 3 wire, 60 Hz operation unless specially ordered otherwise. If your AC mains are different then you will probably have to make a modification in power supply.

50 HZ OPERATION - Unlike most other amplifiers on the market, most Henry amplifiers use a resonant filter choke. The choke is factory resonated at 60 Hz unless otherwise specified. For 50 Hz operation a third resonating capacitor must be added. This will be done at the factory if specified at the time of order.

FILAMENT TRANSFORMER - The filament transformer is marked ECA (1226) (3K Classic) or ECA 1194 (5K Classic). They are factory tapped for 230 VAC operation. If your AC line voltage is significantly different, you must rewire the taps on the transformer (located in the power supply section).

ECA (1226) 1216 A  
-----  
Tap 1 - Common----  
Tap 2 - 200 VAC----  
Tap 3 - 210 VAC----  
Tap 4 - 220 VAC----  
Tap 5 - 230 VAC----  
Tap 6 - 240 VAC

ECA 1194  
-----  
Tap 1 - Common----  
Tap 2 - 200 VAC----  
Tap 3 - 210 VAC----  
Tap 4 - 220 VAC----  
Tap 5 - 230 VAC----  
Tap 6 - 240 VAC----

NOTE: The nominal filament voltage at the tube is 7.5 VAC. The amplifier does not meter filament voltage, so you must use an external AC voltmeter to measure the filament voltage at pin jacks on the back panel of the RF chassis. The 3K Classic should measure close to 7.8 VAC at the pin jacks.

The 5K Classic filaments are in series and the voltage should read about 15.6 VAC. becaif the voltage varies more than 5% from these figures, the taps on the filament transformer should be changed.

HIGH VOLTAGE TRANSFORMER - The 3K Classic Mark II domestic amplifier is supplied with the ECA 1120A. The primary tap connections are listed below:

ECA 1120A  
-----  
230 VAC-----Tap 1  
                  |-----Tap 3  
                  |-----Tap 5  
230 VAC-----Tap 7

The 3K Classic X and 5K Classic are supplied with one of the following high voltage transformers:

(~~ECA 1171~~) or ECA 1214A  
-----  
Common-----Tap 1  
200-210 VAC-----Tap 2  
210-230 VAC-----Tap 3  
230-240 VAC-----Tap 4  
240-250 VAC           TAP 5

The high voltage transformers are located on the bottom plate of the power supply section.

## SECTION 6.9 OTHER PROBLEMS

**AMPLIFIER WILL NOT TURN ON** The most likely cause is the circuit breaker. Check the continuity of the circuit breaker with an ohmmeter if the unit will not turn on or off. Another possible cause is the improper installation of the power plug on the power cable. If the high voltage turns on, but the pilot lights, blower, and relay supply do not come on the 3 AG fuse has blown.

**ALC CIRCUIT SHORTED** A defect in the ALC circuit will prevent the tubes from being driven properly.

**FILAMENT VOLTAGE FAILURE** With a ceramic tube it is not easy to make sure that the filaments are lighting. If the filaments are lighting correctly, the air flow from the amplifier should feel warm. If the filaments are not lighting, the amplifier will not draw any resting plate current when it is keyed. The filament voltage passes through a 4 pin Jones plug into the RF chassis, so you have no filament first check that the plug is properly connected. After that you would have to check the filament transformer, the filament choke on the bottom of the RF chassis, or a problem at the tube socket. Check the filament voltage at the pin jacks on the rear panel of the RF deck. It should be 7.8 VAC for the 3K and 15.6 VAC for the 5K.

## SECTION 6.10 CONTACTING THE FACTORY

If you have any questions concerning the service of the amplifier, you should call or write the amplifier service department at Henry Radio. If it ever becomes necessary to return the amplifier to the factory for repair you should first decide if you need to send the complete amplifier or just the RF chassis. Next pack the equipment in proper packing material to prevent shipping damage, include a short letter describing the exact problem, insure the package for the replacement value of the merchandise, and ship to our amplifier service department. Ceramic power tubes can be shipped installed in the RF chassis.

## SECTION 7. DISASSEMBLING YOUR AMPLIFIER

The description of this procedure uses screw numbers which are shown on Figure 3. Refer to that drawing as necessary. CAUTION: Unplug the amplifier from the AC line before starting this procedure.

**REMOVE THE TOP PANEL** - Remove screws 2, 3, 6, and 7 and pull the top perforated painted panel off of the amplifier.

**REMOVE THE BACK PANEL OF THE POWER SUPPLY** - Remove screws 13, 14, 15, 16, 17, and 18 and pull the back panel away from the power supply section.

**REMOVE CABLES** - Disconnect all of the cables between the RF section and the power supply section.

**REMOVE THE RF DECK** - First remove the BAND, TUNE, and LOAD knobs from the front panel. Then remove two screws from the bottom of the back of the top wraparound. These are accessed by reaching up from the back of the power supply section. They are not shown on the diagram. Remove two screws from the area overhanging the front - screws 19 and 20. The RF deck should now slide out of the back of the wraparound. If you should need to send the RF section back for repair, you should send just the RF chassis, not the complete wraparound. Most service of the amplifier can be accomplished without any further disassembly. The front panel can now be accessed from the rear, the blower from top or bottom, and the power supply from the back.

**REMOVE THE RF WRAPAROUND** - Should you find it necessary to remove the top wraparound, remove the seven screws spaced around the inside bottom lip of the wraparound. They are reached through the top of the amplifier. Next disconnect the meter wiring harness and disconnect the wiring to the blower (below the RF wraparound). The cabinet will then lift off the power supply cabinet.

**REMOVE THE POWER SUPPLY WRAPAROUND** - The RF wraparound must be removed before you can remove the power supply wraparound. Carefully tip the power supply over to remove the four screws holding the painted wraparound to the bottom plate of the power supply. Tip the assembly back upright and then VERY CAREFULLY spread the back edges of the wraparound and slide it off the front of the frame.

FIGURE 4. DISSASSEMBLING YOUR AMPLIFIER.

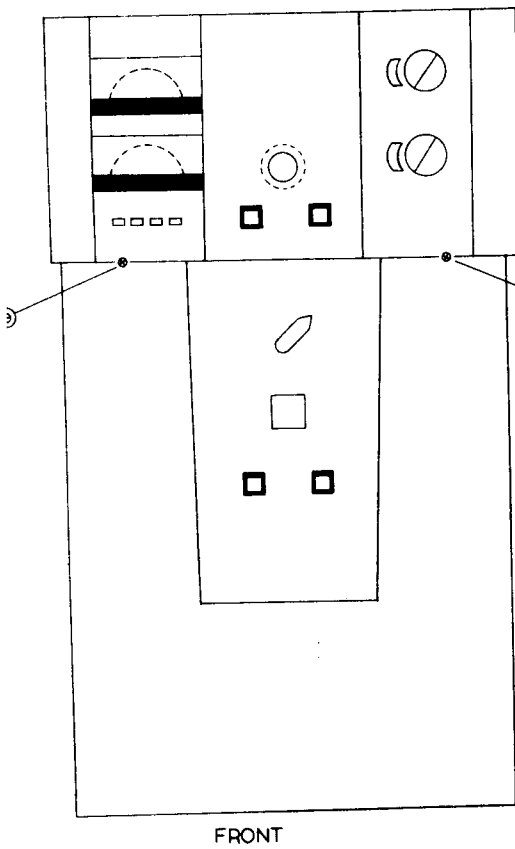
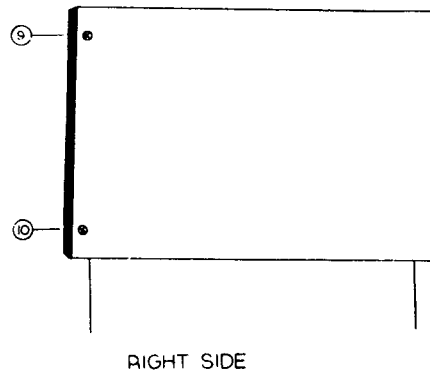
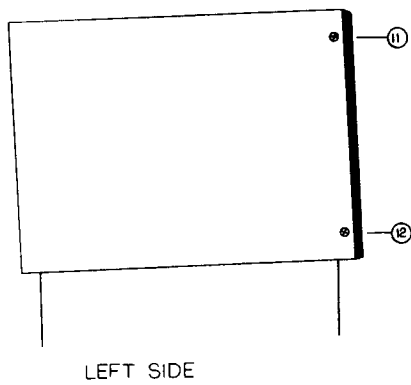
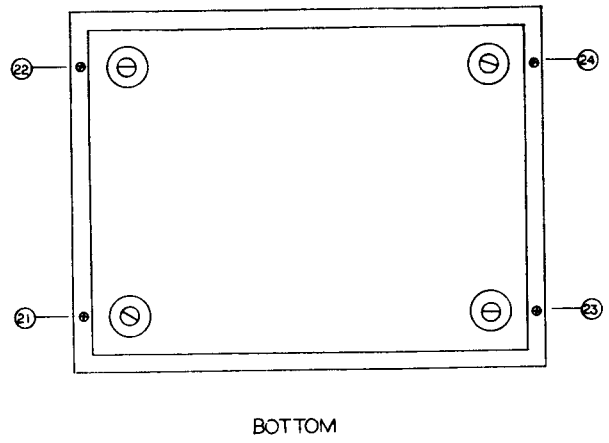
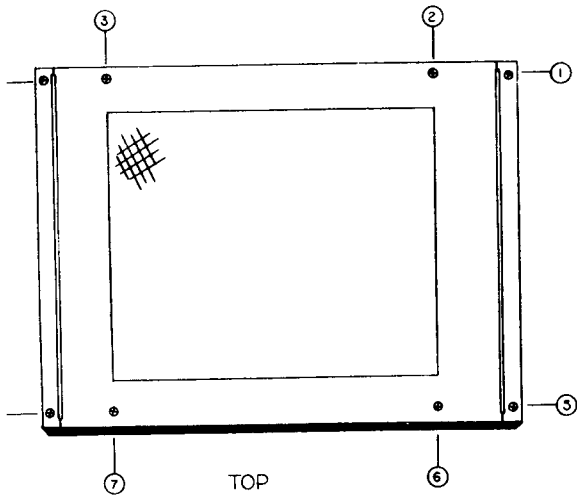

NOTE  
SCREWS 19 AND 20  
ARE LOCATED ON THE  
BOTTOM OF THIS  
SURFACE.

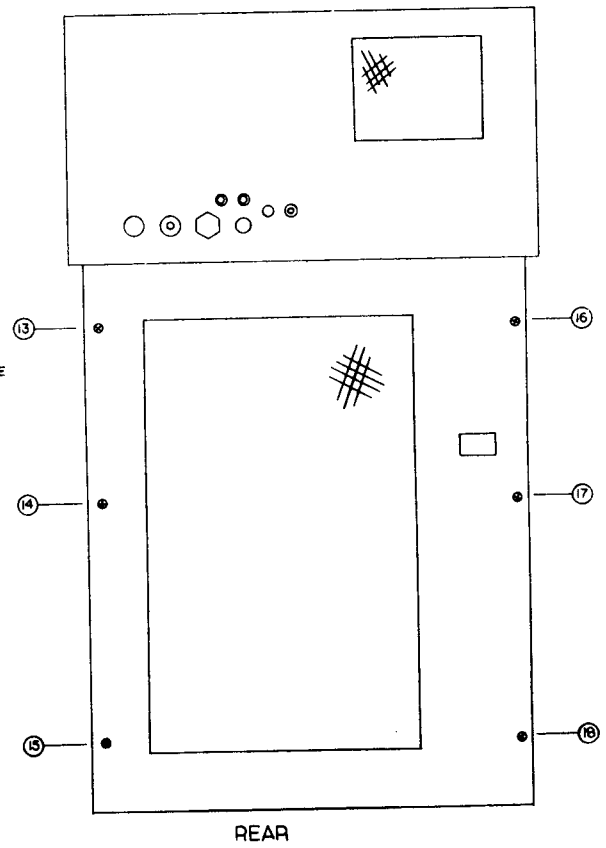

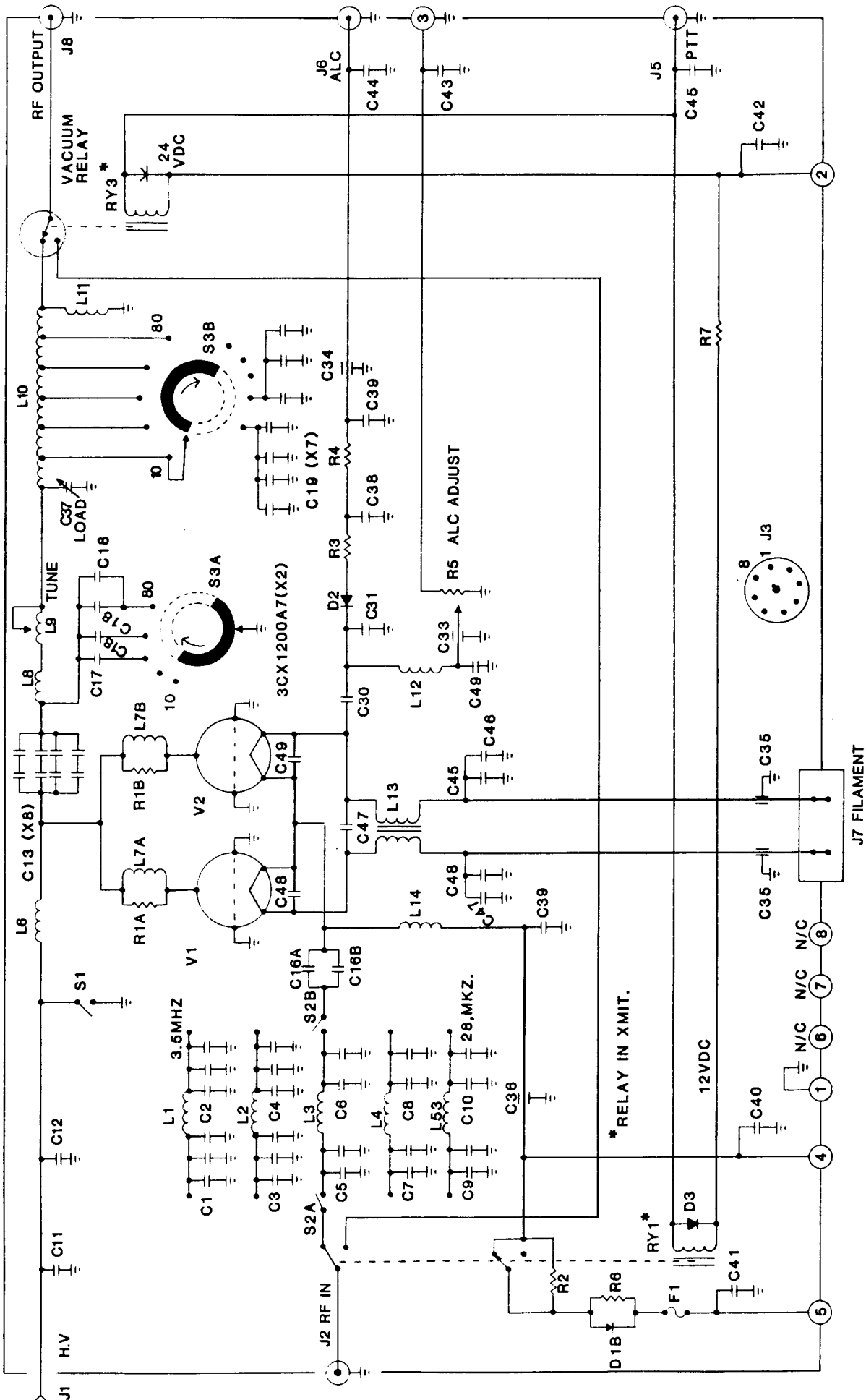

HENRY 5K CLASSIC RF DECK - MARK II











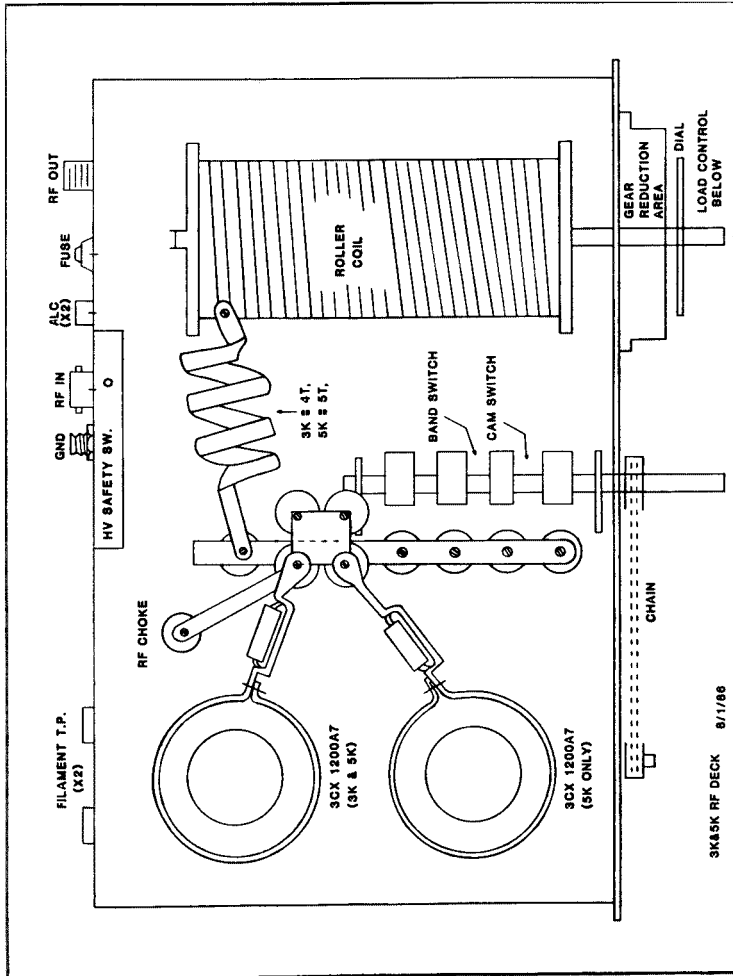

ON CABINET—THIS AREA FOR  
 CW/SSB SW  
 CIRCUIT BREAKERS  
 FUSES(X2)

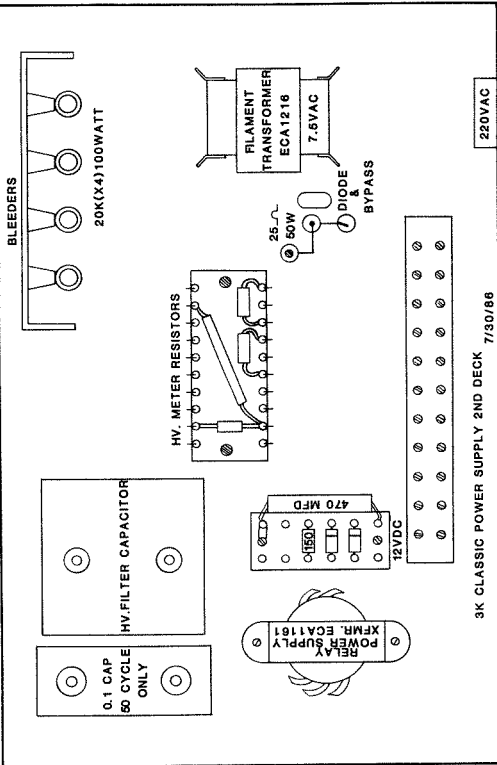

3K CLASSIC POWER SUPPLY 2ND DECK 7/30/86

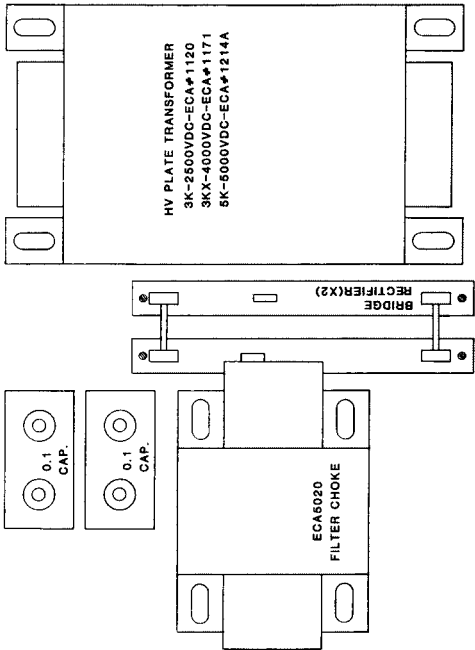

HV PLATE TRANSFORMER  
3K-2500VDC-ECA#1120  
3KX-4000VDC-ECA#1171  
5K-5000VDC-ECA#1214A

ECA5020  
FILTER CHOKE

BRIDGE  
RECTIFIER(X2)

0.1  
CAP.

0.1  
CAP.

ON CABINET--THIS AREA FOR  
SSB/CW  
CIRCUIT BREAKERS(X2)  
FUSES (X2)

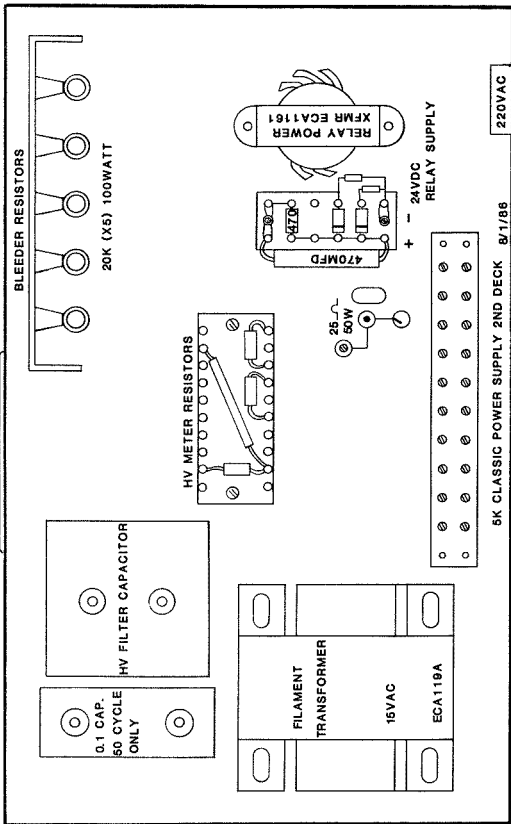

SECTION 9. PARTS LISTS.

NOTE: ALL OF THE BELOW SPECIFICATIONS AND PART NUMBERS ARE SUBJECT TO CHANGE WITHOUT NOTICE BECAUSE OF DESIGN IMPROVEMENTS OR BECAUSE OF THE AVAILABILITY OF PARTS.

B101 BLOWER: 230 VAC, 50/60 HZ SQUIRREL CAGE.....DAYTON 2C915A

CAPACITORS.....

C1A MICA, 620 PF, 500 VDC.....ARCO DM15621J  
 C1B MICA, 200 PF, 500 VDC.....ARCO DM15201J  
 C2A MICA, 620 PF, 500 VDC.....ARCO DM15621J  
 C2B MICA, 200 PF, 500 VDC.....ARCO DM15201J  
 C3A-C4B MICA, 220 PF, 500 VDC.....ARCO DM15221J  
 C5A-C6B MICA, 110 PF, 500 VDC.....ARCO DM15111J  
 C7A MICA, 75 PF, 500 VDC.....ARCO DM15750J  
 C7B MICA, 82 PF, 500 VDC.....ARCO DM15820J  
 C8A MICA, 75 PF, 500 VDC.....ARCO DM15750J  
 C8B MICA, 82 PF, 500 VDC.....ARCO DM15820J  
 C9A-C9B MICA, 50 PF, 500 VDC.....ARCO DM15500J  
 C9C MICA, 220 PF, 500 VDC (5K).....ARCO DM15221J  
 C10A MICA, 100 PF, 500 VDC.....ARCO DM15101J  
 C10B MICA, 20 PF, 500 VDC.....ARCO DM15200J  
 C10C MICA, 22 PF, 500 VDC (5K).....ARCO DM15220J  
 C10D MICA, 160 PF, 500 VDC (5K).....ARCO DM15161J  
 C11-C12 CERAMIC DISC, .0047 MF, 10 KV.....K.D 1000120Z4722  
 C13 x 8 CERAMIC TRANSMITTING, 1000 PF, 5 KV.....HE HT58T102MA  
 C16A CERAMIC DISC, .01 MF, 1 KVDC.....CENTRALAB DD104  
 C16B CERAMIC DISC, .01 MF, 1 KVDC (5K).....CENTRALAB DD104  
 C17 CERAMIC TRANSMITTING, 25 PF, 7.5 KV.....HE HT50V250KA  
 C18 x 3 CERAMIC TRANSMITTING, 75 PF, 7.5 KV.....HE HT50V750KA  
 C19 x 7 CERAMIC TRANSMITTING, 100 PF, 7.5 KV.....HE HT50V101KA  
 C24 CERAMIC TRANSMITTING, 25 PF, 15 KV (5K).....HE HT57V250KA  
 C30-C31 MICA, 470 PF, 500 VDC.....ARCO DM15-471J  
 C33-C36 CERAMIC FEEDTHROUGH, 2000 PF, 500 VDC.....TUSONIX 202M  
 C37 VARIABLE AIR TYPE, 350 PF, LOAD CONTROL.....CARDWELL 154-10  
 C38-C49 CERAMIC DISC, .01 MF, 600 VDC.....CENTRALAB DD6-103  
 C101-C102 OIL FILLED, .01 MF, 7.5 KV.....PLASTIC CAP. LK80-104  
 C103 OIL FILLED, 16 MF, 8 KV.....AERVOX BX0015D0008A  
 C104 ELECTROLYTIC, 470 MF, 50 VDC.....ARCO ME-470-50  
 C105 CERAMIC DISC, .05 MF, 16 VDC.....CENTRALAB UK16-503  
 C106 OIL FILLED, .01 MF, 7.5 KV (50 HZ ONLY)...PLASTIC CAP. LK80-104  
 C107 CERAMIC DISC, .05 MF, 16 VDC.....CENTRALAB UK16-503  
 C108-C109 CERAMIC DISC, .01 MF, 600 VDC.....CENTRALAB DD106-103

CB101 CIRCUIT BREAKER: 30 AMPS, 250 VAC (3K).....P & B W92X11-2-30  
 CB102 CIRCUIT BREAKER: 40 AMPS, 250 VAC (5K).....P & B W92X11-2-40

CONNECTORS-----

J1 (3K) HIGH VOLTAGE SOCKET AND PLUG.....MILLEN 37501  
 J1 (5K) HIGH VOLTAGE SOCKET AND PLUG.....HENRY  
 J2 RF INPUT, BNC TYPE COAX CONNECTOR.....AMPHENOL UG647/U  
 J3 HARNESS CONNECTOR, 8 PIN SOCKET.....AMPHENOL 78S8  
 J4 RF OUT, UHF TYPE COAX CONNETOR (3K ONLY).....AMPHENOL S0239

J5	RELAY CONTROL, RCA TYPE PHONO JACK.....	SWITCHCRAFT 3501FP
J6	ALC FEEDBACK, RCA TYPE PHONO JACK.....	SWITCHCRAFT 3501FP
J7	FILAMENT CONNECTOR, 4 PIN JONES PLUG.....	CINCH P404AB
J8	RF OUT, N TYPE COAX CONNECTOR (5K ONLY).....	AMPHENOL UG58A/U
J101	AC INPUT, 6 PIN JONES PLUG.....	CINCH P404AB
J102	HARNESS CONNECTOR, 8 PIN PLUG.....	AMPHENOL 86CP8
J103	FILAMENT CONNECTOR, 4 PIN JONES SOCKET.....	CINCH S404CCT
J105	AC INPUT, 6 PIN JONES SOCKET.....	CINCH S404CCT

DIODES-----

D1A (3K)	BIASING DIODE, 10 VDC, 1.2 AMPS.....	CSDC 45XV245
D1A (5K)	BIASING DIODE, 10 VDC, 2 AMPS.....	CSDC 423PD10AE1
D2	RECTIFIER, 1 AMP, 200 PIV, ALC.....	MOTOROLA 1N458
D3	RECTIFIER, 1 AMP, 1000 PIV.....	GE 509
D101-D102	RECTIFIER, 1.2 AMP, 15 KV.....	CSDC 45XV246
D103-D104	RECTIFIER, 1 AMP, 1000 PIV.....	GE 509
D105-D106	RECTIFIER, 1 AMP, 1000 PIV (5K ONLY).....	GE 509
D107	RECTIFIER, 3 AMP, 100 PIV.....	MOTOROLA 1N4720
D108	RECTIFIER, 1 AMP, 400 PIV.....	MOTOROLA 1N4004
D109	VOLTAGE SPIKE PROTECTOR, 250 VAC.....	PANASONIC ERZC20DK681
F1	FUSE: CATHODE PROTECTION, 8 AG, 1.5 AMP....	LITTELFUSE 361-001.5
	FUSEHOLDER: 8 AG.....	LITTELFUSE 372-001A
F101-F102	FUSE: AC MAINS, 3 AG, 3 AMP.....	LITTELFUSE 312-003
	FUSEHOLDER: 3 AG.....	LITTELFUSE 342-875
KNOB	BAND SWITCH, TUNE CONTROL, LOAD CONTROL.....	RAYTHEON 175-1-26
KNOB	SSB/CW SWITCH.....	RAYTHEON 70-7WL-26

INDUCTORS-----

L1	INPUT COIL, 3.5 MHZ.....	HENRY L1 3K CLASSIC
L2	INPUT COIL, 7.0 MHZ.....	HENRY L2 3K CLASSIC
L3	INPUT COIL, 14.0 MHZ.....	HENRY L3 3K CLASSIC
L4	INPUT COIL, 21.0 MHZ.....	HENRY L4 3K CLASSIC
L5A	INPUT COIL, 28.0 MHZ (3K ONLY).....	HENRY L5 3K CLASSIC
L5B	INPUT COIL, 28.0 MHZ (5K ONLY).....	HENRY L5 5K CLASSIC
L6	HIGH VOLTAGE RF PLATE CHOKE.....	HENRY L6 3K CLASSIC
L7A-L7B	PARASITIC SUPPRESSOR COIL.....	HENRY L7 3K CLASSIC
L8	10 METER RF OUTPUT COIL (EXPORT MODELS)....	HENRY L8 3K CLASSIC
L9	VARIABLE ROTARY INDUCTOR, LOAD CONTROL.....	HENRY L9 3K CLASSIC
L10	L-SECTION TAPPED COIL.....	B & W 1608-002
L11	RF ANTENNA CHOKE, 2.5 MH, 150 MA.....	MILLER 4555
L13	FILAMENT CHOKE, TOROID.....	HENRY L13 3K CLASSIC
L14	FILAMENT CENTERTAP CHOKE (5K only).....	MILLER 6302
L101	RESONATING FILTER CHOKE, 8 H, 800 MA.....	ECA 5020
M101	METER: PLATE CURRENT, 0 TO 1 AMP.....	BEEDE 913105
M102	METER: MULTIMETER, 0 TO 1 MA.....	BEEDE 913104

PILOT LIGHTS-----

PL101-PL102	TUNE AND LOAD DIAL LAMP (3K).....	SYLVANIA 1829
	LIGHT HOLDER ASSEMBLY.....	SMITH 1931
PL103-PL104	STANDBY AND POWER LIGHT (3K).....	SYLVANIA 327
	LIGHT HOLDER ASSEMBLY.....	COMPULITE 621-1-B
PL105-PL106	TUNE AND LOAD DIAL LAMP (3K).....	SYLVANIA 1829



PL107-PL108 STANDBY AND POWER LIGHT (5K).....SYLVANIA 85

RY1 RELAY: INPUT SECTION, 12 VDC, DPDT.....GUARDIAN 1365PC  
RY2 (3K) RELAY: OUTPUT SECTION, 12 VDC, DPDT.....GUARDIAN 1365PC  
RELAY SOCKET.....GUARDIAN 1365  
RY3 (5K) RELAY: VACUUM OUTPUT RELAY.....ITT JENNINGS RJ2B TYPE

RESISTORS-----

R1A-R1B CARBON, 50 OHMS, 10 WATTS, 10%.....RESISTOR  
R2 WIREWOUND, 10 K OHMS, 10 WATTS, 10%.....RESISTOR  
R3 CARBON, 1 K OHMS, 1 WATT, 10%.....RESISTOR  
R4 CARBON, 68 K OHMS, 1 WATT, 10%.....RESISTOR  
R5 POTENTIOMETER: WIREWOUND, 100 K OHMS, 5 WATTS....A & B JLU TYPE  
R6 CARBON, 220 OHMS, 1 WATT, 10%.....RESISTOR  
R7 CARBON, 130 OHMS, 2 WATTS, 10% (5K).....RESISTOR  
R102 CARBON, 150 OHMS, 2 WATTS, 10%.....RESISTOR  
R103 CARBON, 470 OHMS, 2 WATTS, 10% (5K).....RESISTOR  
R104A PRECISION, 0.1 OHM, 1 WATT, 1%.....RESISTOR  
R106 WIREWOUND, 25 OHMS, 25 WATTS, 5%.....RESISTOR  
R107 x 5 WIREWOUND, 20 K OHMS, 100 WATTS, 5% (3K x 4).....RESISTOR  
R111-R112 CARBON, 47 K OHMS, 2 WATTS, 10%.....RESISTOR  
R113 PRECISION, 10 M OHMS, 7.5 WATTS, 1%.....RESISTOR  
R117 CARBON, 10 K OHMS, 2 WATTS, 10%.....RESISTOR  
R118 CARBON, 150 OHMS, 1 WATT, 10%.....RESISTOR  
R119 CARBON, 470 OHMS, 1 WATT, 10%.....RESISTOR  
R120-R122 WIREWOUND, 10 OHM, 50 WATT, 5% (5K).....RESISTOR  
R124 CARBON, 5 K OHMS, 1 WATT, 10%.....RESISTOR

SWITCHES-----

S1 HIGH VOLTAGE SHORTING SWITCH.....HENRY S1 3K CLASSIC  
S2 BAND SWITCH, INPUT SECTION.....CENTRALAB 2504  
S3A-S3B BAND SWITCH, TUNED CIRCUIT SECTION.....HENRY S3A 3K CLASSIC  
S101A-S101B FUNCTION SWITCH, METER, STANDBY, ETC.....SWITCHCRAFT 65041K206  
S102 AIRFLOW PROTECTION SWITCH.....ROTRON 2A-1000  
S103 HIGH VOLTAGE, SSB/CW SWITCH.....HENRY S103 3K CLASSIC

TRANSFORMERS-----

T101 HIGH VOLTAGE (3K DOMESTIC).....ECA 1120  
T102 HIGH VOLTAGE (3K EXPORT).....ECA 1171  
T103 HIGH VOLTAGE (5K).....ECA 1214A  
T104 FILAMENT, 7.5 VAC (3K).....ECA 1216  
T105 FILAMENT, 15.0 VAC (5K).....ECA 1194  
T106 RELAY SUPPLY.....ECA 1161

V1-V2 TUBE: CERAMIC TRANSMITTING TRIODE.....EIMAC 3CX1200A7  
TUBE SOCKET: CERAMIC.....JOHNSON 122-0275-001  
TUBE CHIMNEY: TEFLON.....HENRY 3K CLASSIC CHIMNEY

The EIMAC 3CX1200A7 is a high  $\mu$ , compact, forced-air cooled, rugged, ceramic/metal power triode, intended to be used as a zero-bias Class AB<sub>2</sub> amplifier. Grounded grid operation is also attractive since a power gain as high as twenty times can be obtained in a cathode-driven circuit.



## GENERAL CHARACTERISTICS<sup>1</sup>

### ELECTRICAL

Filament: Thoriated Tungsten

Voltage .....	7.5 Volts $\pm$ 0.37 V
Current .....	21.3
Frequency for Maximum Ratings.....	110 MHz
Amplification Factor .....	200

Interelectrode Capacitances (grounded filament connection)<sup>2</sup>

Input .....	20 pF
Output (max) .....	0.6 pF
Feedback.....	10.3 pF

Interelectrode Capacitances (grounded grid connection)<sup>2</sup>

Input .....	20 pF
Output .....	10.3 pF
Feedback (max).....	0.6 pF

### MECHANICAL

Cooling.....	Forced Air
Maximum Operating Temperatures	
Plate Seal .....	250°C
Base Seal .....	250°C
Mounting Position .....	Vertical, Base Up or Down
Socket .....	SK410
Chimney .....	SK436
Maximum Length .....	6.0 in; 147 mm
Maximum Diameter .....	2.91 in; 73.1 mm
Weight (Approximate).....	2.5 lb; 1.1 kg

<sup>1</sup> Characteristics and operating values are based upon performance tests. These figures may change without notice as the result of additional data or product refinement. Varian EIMAC should be consulted before using this information for final equipment design.

<sup>2</sup> Capacitance values are for a cold tube as measured in a special shielded fixture in accordance with Electronic Industries Association Standard RS-191.

## RADIO FREQUENCY LINEAR AMPLIFIER CATHODE DRIVEN Class AB<sub>2</sub>

### TYPICAL OPERATION

(Frequencies to 30 MHz) Class AB<sub>2</sub>, Cathode Driven, Peak Envelope or Modulation Crest Conditions

Plate Voltage .....	2500	3000	3500	4000	Vdc
Cathode Voltage <sup>1</sup> .....	0	0	0	0	Vdc
Zero-Signal Plate Current <sup>3</sup> .....	130	165	205	240	mA dc
Single-Tone Plate Current .....	800	800	800	800	mA dc
Two-Tone Plate Current .....	540	560	570	565	mA dc
Single-Tone Grid Current <sup>3</sup> .....	255	250	275	250	mA dc
Two-Tone Grid Current <sup>3</sup> .....	140	130	140	112	mA dc
Peak rf Cathode Voltage <sup>3</sup> .....	115	105	120	115	vAc
Peak Driving Power <sup>3</sup> .....	102	105	110	100	W
Single-Tone Useful Output Power <sup>3</sup> .....	1250	1600	1870	2055	W
Resonant Load Impedance .....	1750	2080	2430	2780	ohms
Intermodulation Distortion Products <sup>2</sup>					
3rd Order .....	-37	-35	-30	-33	dB
5th Order .....	-42	-47	-43	-48	dB

<sup>1</sup> Positive cathode bias may be provided by a zener diode.

<sup>2</sup> The intermodulation distortion products are referenced against one tone of a two-equal-tone signal

<sup>3</sup> Approximate values.

### MAXIMUM RATINGS:

DC Plate Voltage .....	5500 V
DC Plate Current .....	0.9 Adc
Grid Dissipation .....	50 W
Plate Dissipation .....	1200 W

## RADIO FREQUENCY POWER AMPLIFIER CATHODE DRIVEN Class C

### TYPICAL OPERATION

Carrier Conditions, Frequencies to 30 MHz .

Plate Voltage .....	5000	Vdc
Cathode Voltage .....	+65	Vdc
Plate Current .....	800	mA dc
Grid Current .....	240	mA dc
Plate Load Resistance .....	3200	ohms
Driving Power .....	43	W
Plate Output Power .....	2700	W
Power Gain .....	18	dB

### MAXIMUM RATINGS:

DC Plate Voltage .....	5500 V
DC Plate Current .....	0.9 Adc
Grid Dissipation .....	50 W
Plate Dissipation .....	1200 W

## RANGE VALUES FOR EQUIPMENT DESIGN

	Min	Max	
Filament Current at 7.5V .....	20.0	22.7	Aac
Direct Interelectrode Capacitance (grounded grid connection)			
Input .....	18.5	22.5	pF
Output .....	8.8	11.8	pF
Feedback .....	—	0.9	pF
Direct Interelectrode Capacitance (grounded cathode connection)			
Input .....	18.5	22.5	pF
Output .....	—	0.9	pF
Feedback.....	8.8	11.8	pF

## APPLICATION

### MECHANICAL

**MOUNTING:** The 3CX1200A7 must be operated vertically, base up or down. A flexible connecting strap should be provided between plate connector and external plate circuit. The tube must be protected from severe vibration and shock.

**SOCKET:** The EIMAC SK-410 air system socket and SK-436 chimney are recommended for use with the 3CX1200A7. When a socket other than the SK-410 is used, provisions must be made for equivalent cooling of the base, the envelope, and the plate lead.

If a socket other than the EIMAC SK-410 is used, the user should assure himself that strong lateral pressure is not applied to the tube base pins. Otherwise, even though the base of the tube is reinforced, damage to the base seals may result.

**COOLING:** Forced-air cooling is required to maintain the base seals at a temperature below 250° C, and the plate seal at a temperature below 250° C. Air flow requirements to maintain the above maximum temperatures are shown on cooling data curve.

At 1200 W of plate dissipation an airflow of 30 cfm with a back pressure of 0.5 inches of water should be applied and directed through the fins of the tube. A minimum of 5 cfm must be supplied to the base of tube whenever the filament voltage is on.

In all cases, the only criterion of proper cooling is the temperature of the tube seals. Tube temperatures may be measured with temperature sensitive paint, spray, or crayon.

**HOT SURFACES:** When the tube is used in air and air cooled, external surfaces may reach temperatures up to 200 degrees C and higher. In addition to the anode, the cathode insulator and cathode-heater surfaces especially may reach the high temperatures. All hot surfaces may remain hot for an extended time after the tube is shut off. To prevent serious burns, take care to avoid any bodily contact with these surfaces, both during, and for a reasonable cool-down period after, tube operation.

### ELECTRICAL

**ABSOLUTE MAXIMUM RATINGS:** Values shown for each type of service are based on the "absolute system" and are not to be exceeded under any service conditions. These ratings are limiting values outside which the serviceability of the tube may be impaired. In order not to exceed absolute ratings, the equipment designer has the responsibility of determining an average design value for each rating below the absolute value of that rating by a safety factor so that the absolute values will never be exceeded under any usual conditions of supply voltage variation in the equipment itself. It does not necessarily follow that combinations of absolute maximum ratings can be attained simultaneously.

**ZERO-BIAS OPERATION:** Operation at zero-bias is not recommended with plate voltages over 4000 since plate dissipation may be exceeded. A zener diode placing positive bias on the cathode or other constant voltage source may be used to reduce zero signal plate current at plate potentials over 4000 volts.

**CLASS-C OPERATION:** Although specifically designed for linear amplifier service, the 3CX1200A7 may be operated as a class-C power amplifier or oscillator or as a plate-modulated radio-frequency power amplifier. The zero-bias characteristic of the 3CX1200A7 can be used to advantage in class-C amplifiers operating at plate voltages of 4000 volts or below by employing only grid-resistor bias. If driving power fails, plate dissipation is then kept to a low value because the tube will be operating at the normal static zero-bias conditions.

**FILAMENT OPERATION:** The rated filament voltage for the 3CX1200A7 is 7.5 volts. Filament voltage, as measured at the socket, must be maintained within the range of 7.87 to 7.13 volts to obtain maximum tube life.

For best tube life the inrush current to the filament should be limited to two times normal current during turn-on. This will minimize thermal stress on the thoriated-tungsten filament wire, which can cause internal tube geometry changes with repeated cycling.

**HIGH VOLTAGE:** Operating voltage for the 3CX1200A7 can be deadly, so the equipment must be designed properly and operating precautions must be followed. Design equipment so that no one can come in contact with high voltages. All equipment must include safety enclosures for high voltage circuits and terminals, with interlock switches to open the primary circuits of the power supply and to discharge high voltage capacitors whenever access doors are opened. Interlock switches must not be bypassed or "cheated" to allow operation with access doors open. Remember that HIGH VOLTAGE CAN KILL.

**INTERMODULATION DISTORTION:** Typical operating conditions with distortion values included are the result of data taken during actual operation at 2 megahertz. Intermodulation values listed are those measured at the full peak envelope power noted.

**INTERELECTRODE CAPACITANCE:** The actual internal interelectrode capacitance of a tube is influenced

by many variables in most applications such as stray capacitance to the chassis, capacitance added by the socket used, stray capacitance between the tube terminals, and wiring effects. To control the actual capacitance values within the tube as the key component involved, the industry and military services use a standard test procedure as described in Electronic Industries Association Standard RS-191. This requires the use of specially constructed test fixtures which effectively shield all external tube leads from each other and eliminate any capacitance reading to "ground." The test is performed on a cold tube. Other factors being equal, controlling internal tube capacitance in this way normally assures good interchangeability of tubes over a period of time, even if the tube is made by different manufacturers. The capacitance values shown in the manufacturer's technical data, or test specifications, normally are taken in accordance with Standard RS-191.

The equipment designer is, therefore, cautioned to make allowance for the actual capacitance values which will exist in any normal application. Measurements should be taken with the socket and mounting which represent approximate final layout if capacitance values are highly significant in the design.

**INPUT CIRCUIT:** When the 3CX1200A7 is operated as a grounded-grid rf amplifier, the use of a resonant tank in the cathode circuit is recommended in order to obtain greatest linearity and power output. For best results with a single-ended amplifier it is suggested that the cathode tank circuit operate at a Q of two or more.

**SPECIAL APPLICATIONS:** If it is desired to operate this tube under conditions widely different from those given here, write to the Varian Electron Device Group Sales Office or the Product Manager, Varian EIMAC, 1678 Pioneer Rd., Salt Lake City, UT 84104, for information and recommendation.

# COOLING DATA

3CX1200A7

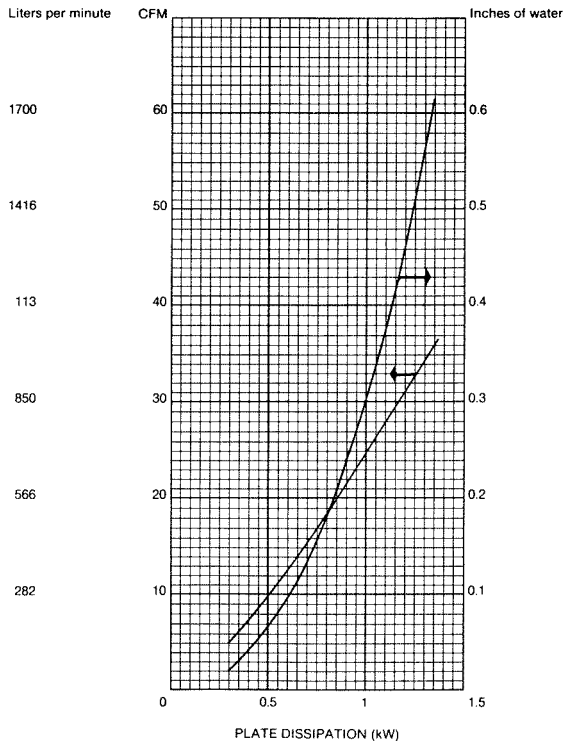

CFM and pressure required to keep anode temperature at 225°C.

Standard conditions 25°C at 29.92 in. Hg

1 PAS = .00407 X In. of water

1 cubic meter/min. =  $2.832 \times 10^{-2}$  X CFM

**EIMAC 3CX1200A7  
CONSTANT CURRENT  
CHARACTERISTICS**

GROUNDING CATHODE  
—— PLATE CURRENT — AMPERES  
----- GRID CURRENT — AMPERES

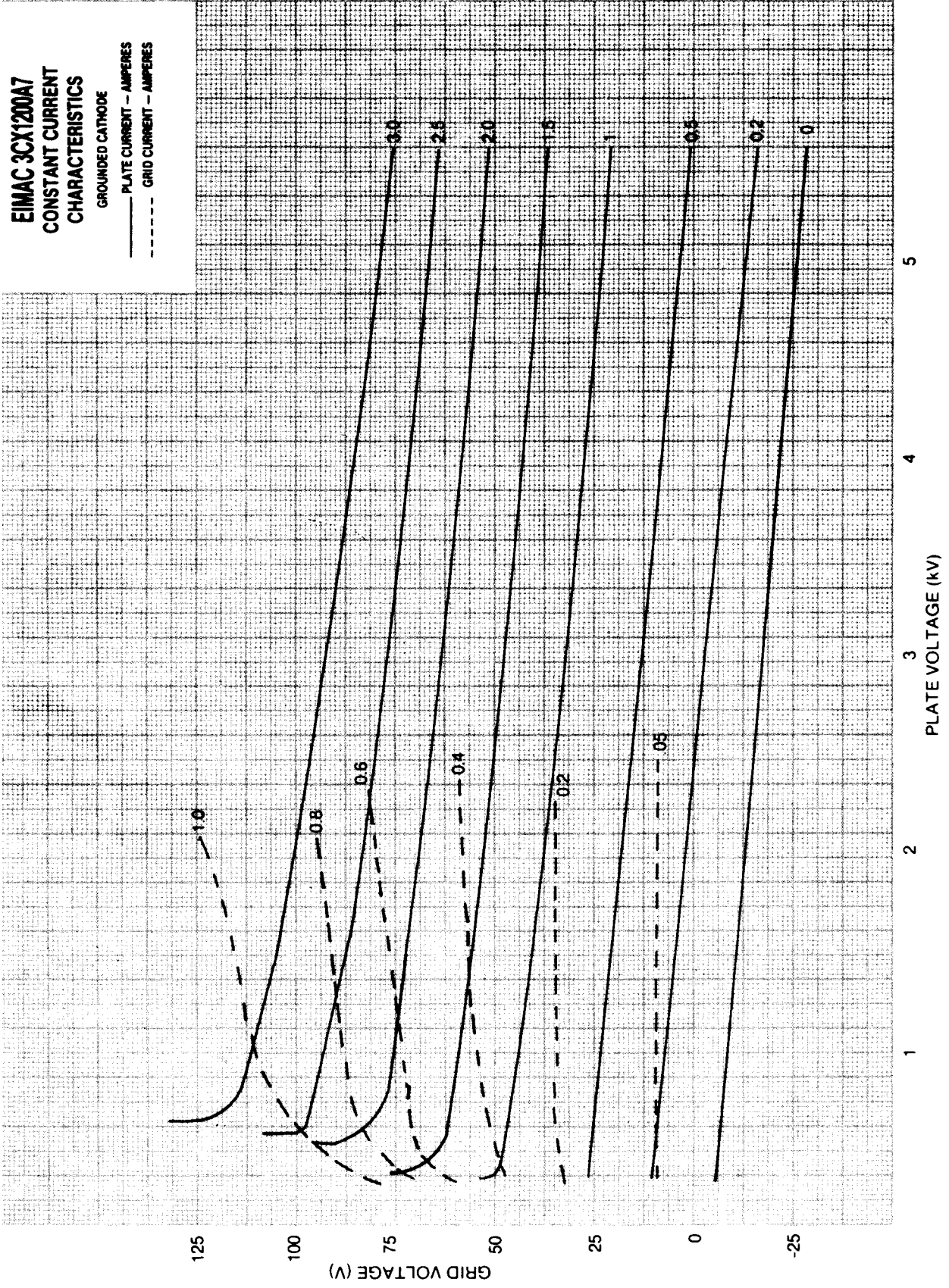







## SECTION 12. WARRANTY

### LIMITED WARRANTY

---

Henry Radio warrants each new Henry amplifier to be free from defective material and workmanship and agrees to remedy any such defect or to furnish a new part in exchange for any part of any unit which under normal installation, use, and service discloses such defect, provided the unit, or part is delivered by the original owner to us intact for our examination, with all transportation charges prepaid to our factory, within ninety days from the date of sale to the original purchaser and provided that such examination discloses in our judgement that it is thus defective. Should a malfunction be suspected, write in detail to our service department for suggestions concerning the operation, repair, or return of your unit if it should prove necessary.

**EXCLUSION:** Henry Radio does not warranty vacuum tubes used in their equipment. Eimac tubes are warranted by Eimac on a pro-rated one year basis. All other tubes are not warranted.

**EXCLUSION:** Warranty claims will only be honored when accompanied by proof of purchase which shows the purchase date.

**EXCLUSION:** This warranty does not extend to any of our radio products that have been subjected to misuse, neglect, accident, incorrect wiring not our own, improper installation, or to use in violation of the instructions furnished by us, nor extend to units which have been repaired or altered outside the factory without our permission, nor in any cases where the serial number thereof has been removed or defaced or changed, nor to units used with accessories not manufactured or recommended by us.

The above warranty does not include incidental or consequential damages and the distributor disclaims any liability for any such damage. All implied warranties, if any, are limited in duration to the above stated 90 day warranty period. Some states do not allow the exclusion or limitation of incidental or consequential damages or on how long an implied warranty lasts, so the above limitations may not apply to you.

Henry Radio reserves the right to make any improvements to its products which it may deem desirable without obligation to install such improvements in its previously sold products.